

Product: ISVH 120

Product code: 90281

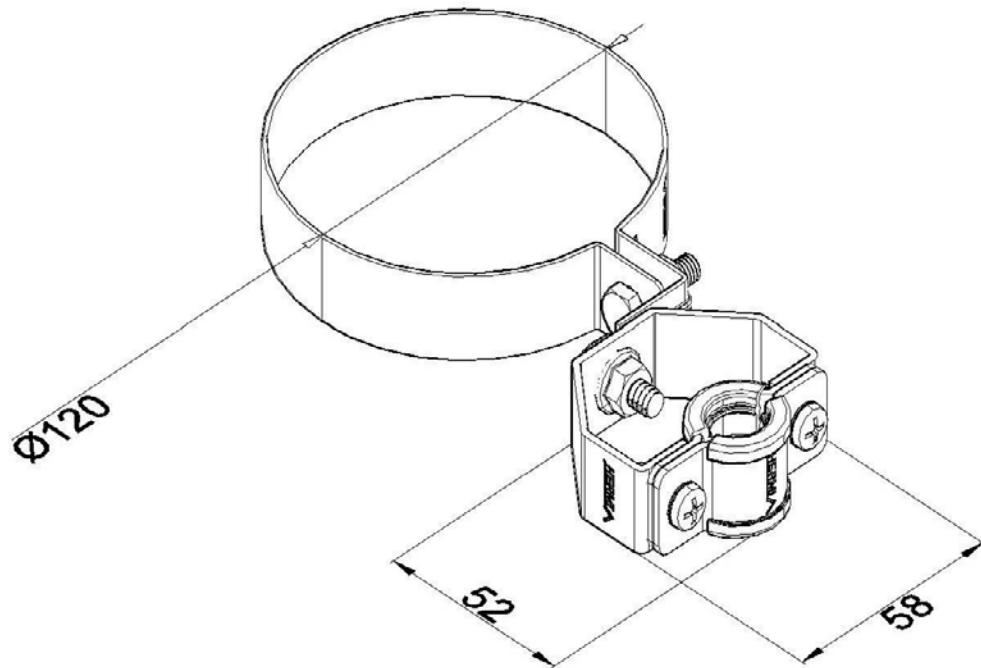

Standard:	EN IEC 62561-2:2018: Lightning Protection System Components (LPSC) - Part 2: Requirements for conductors and earth electrodes
Dimensions:	Length: 58 mm
	Width: 52 mm
	Height:
	Diameter: ϕ 120 mm
	Weight:
Material:	Stainless steel