

Product: Flat conductor Cu 30x4

Product code: 90118

Bonding bar

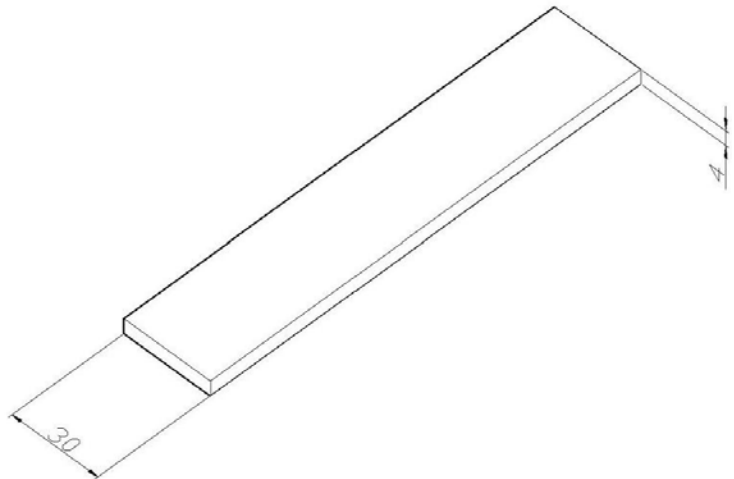

Standard:	EN IEC 62561-2:2018 : Lightning Protection System Components (LPSC) - Part 2: Requirements for conductors and earth electrodes
Dimensions:	Length:
	Dimension: 30x4 mm
	Weight: 1 kg
Material:	Copper
Tensile strength:	200 N/mm ² - 450 N/mm ²
Maximum electrical resistivity:	0,019 μΩm