

Product: SON08

Product code: 807

Roof ridge conductor fastener

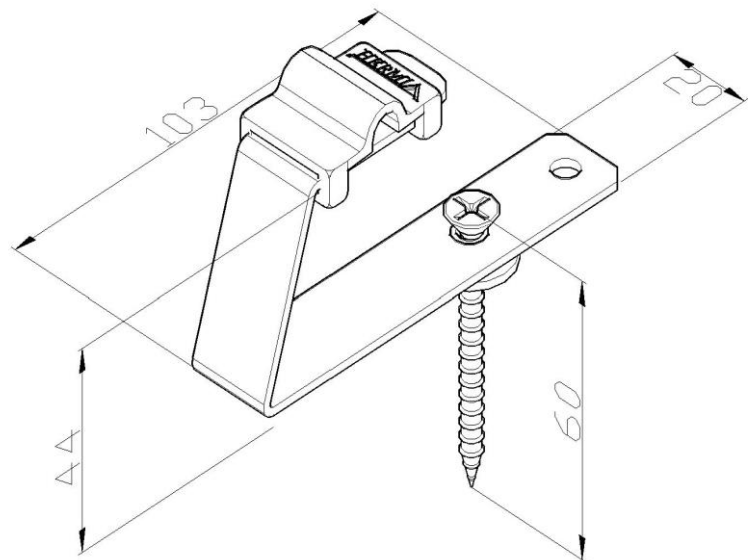

Standard:	EN 62561-4:2017: Lightning protection system components (LPSC) - Part 4: Requirements for conductor fasteners
Dimensions:	Length: 103 mm
	Width: 20 mm
	Height: 44 mm
	Conductor diameter: $\phi 8$ mm
	Weight: 0,09 kg
Material:	Copper