

Product: KON11 A

Product code: 700334

Pipe bonding clamp

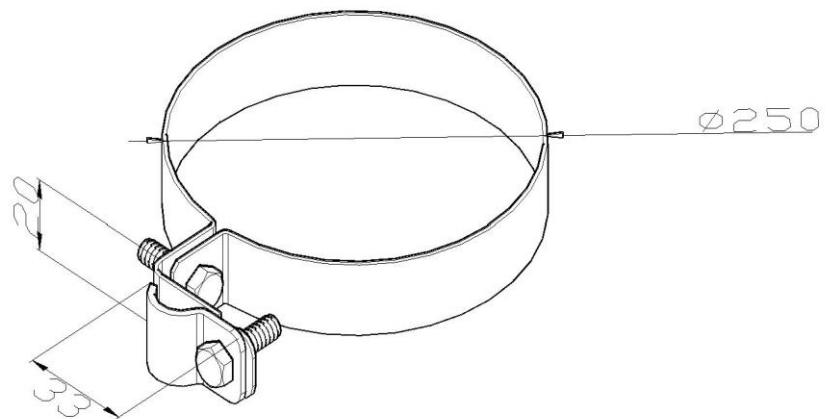

Standard:	EN 62561-4:2017 Lightning Protection System Components (LPSC) - Part 4: Requirements for conductor fasteners
Dimensions:	Clamp diameter: $\phi 250$ mm
	Conductor dimensions: $\phi 8-10$ mm
	Weight: 0,15 kg
Material:	Stainless steel