

**Product:** KON11 A

**Product code:** 700290

Pipe bonding clamp

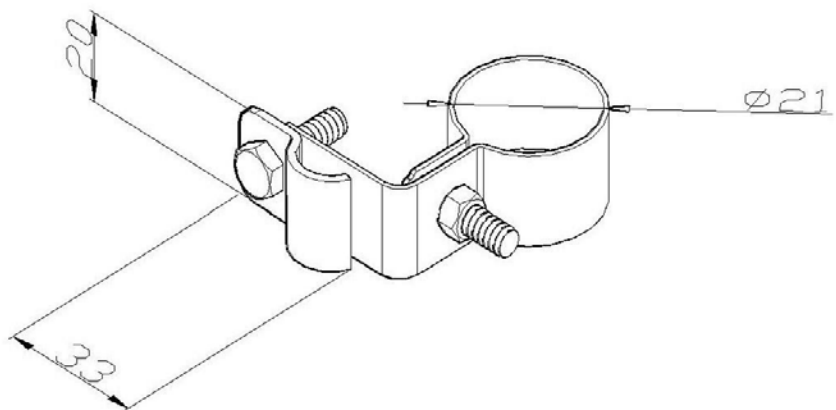

<b>Standard:</b>	EN 62561-4:2017 Lightning Protection System Components (LPSC) - Part 4: Requirements for conductor fasteners
<b>Dimensions:</b>	Clamp diameter: $\phi 21(1/2")$ mm
	Conductor dimensions: 16-35 mm <sup>2</sup>
	Weight: 0,05 kg
<b>Material:</b>	Stainless steel