

Product: KON10 A

Product code: 700182

Pipe bonding clamp

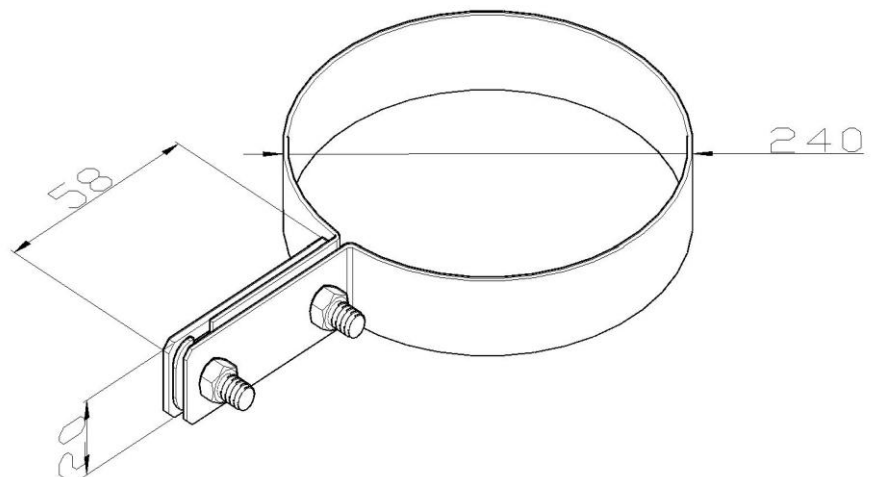

Standard:	EN 62561-4:2017 Lightning Protection System Components (LPSC) - Part 4: Requirements for conductor fasteners
Dimensions:	Clamp diameter: $\phi 240$ mm
	Conductor dimensions: P30x4 mm
	Weight:
Material:	Copper