

**Product:** KON10 A

**Product code:** 700180

Pipe bonding clamp

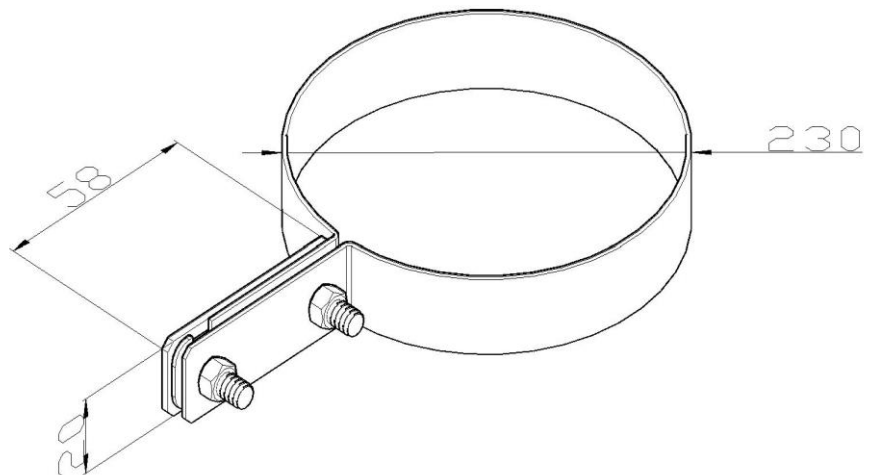

<b>Standard:</b>	EN 62561-4:2017 Lightning Protection System Components (LPSC) - Part 4: Requirements for conductor fasteners
<b>Dimensions:</b>	Clamp diameter: $\phi 230$ mm
	Conductor dimensions: P30x4 mm
	Weight:
<b>Material:</b>	Copper