

Product: KON10 A

Product code: 700143

Pipe bonding clamp

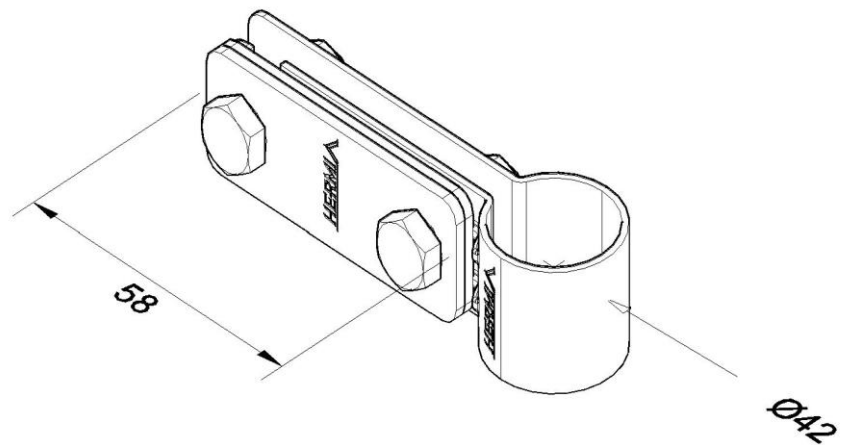

Standard:	EN 62561-4:2017 Lightning Protection System Components (LPSC) - Part 4: Requirements for conductor fasteners
Dimensions:	Clamp diameter: $\phi 42(5/4")$ mm
	Conductor dimensions: P up to 30 mm
Material:	Weight:
	Copper