

Product: KON11 A

Product code: 700130

Pipe bonding clamp

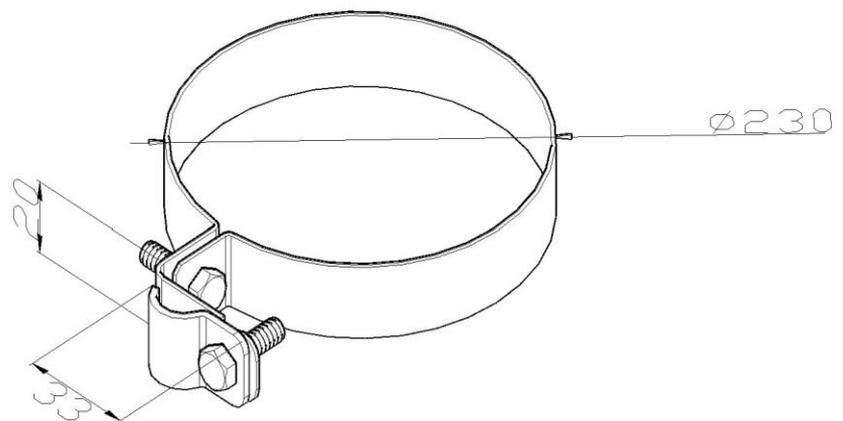

Standard:	EN 62561-4:2017 Lightning Protection System Components (LPSC) - Part 4: Requirements for conductor fasteners
Dimensions:	Clamp diameter: ϕ 230 mm
	Conductor dimensions: ϕ 8-10 mm
Material:	Weight:
	Copper