

**Product:** KON11 A

**Product code:** 700104

Pipe bonding clamp

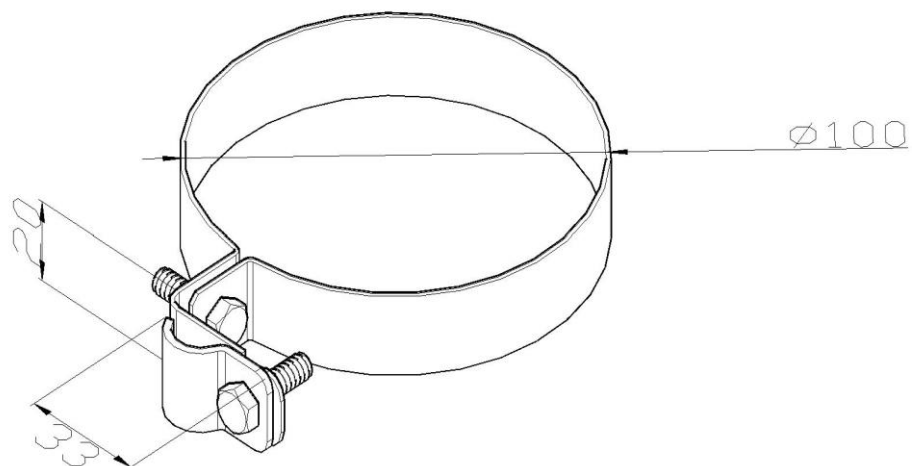

<b>Standard:</b>	EN 62561-4:2017 Lightning Protection System Components (LPSC) - Part 4: Requirements for conductor fasteners
<b>Dimensions:</b>	Clamp diameter: $\phi$ 100 mm
	Conductor dimensions: $\phi$ 8-10 mm
	Weight: 0,1 kg
<b>Material:</b>	Copper