

Product: KON11 A

Product code: 700093

Pipe bonding clamp

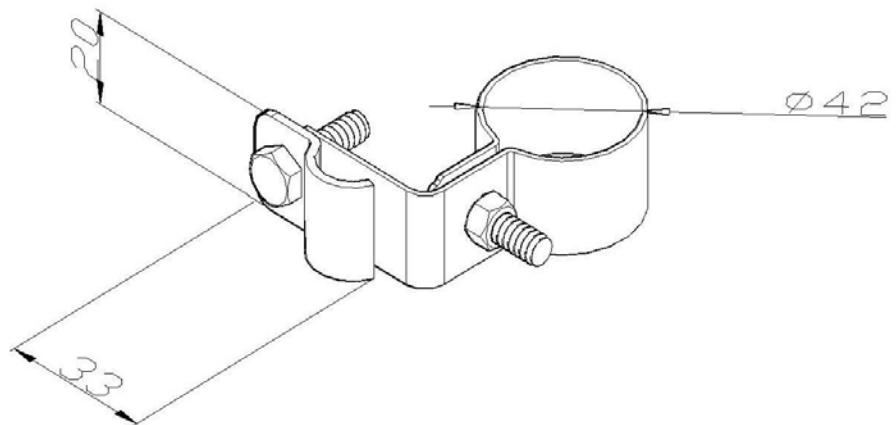

Standard:	EN 62561-4:2017 Lightning Protection System Components (LPSC) - Part 4: Requirements for conductor fasteners
Dimensions:	Clamp diameter: $\phi 42(5/4")$ mm
	Conductor dimensions: 16-35 mm ²
	Weight: 0,06 kg
Material:	Copper