

**Product:** SON05 brown

**Product code:** 5220

Roof ridge conductor fastener

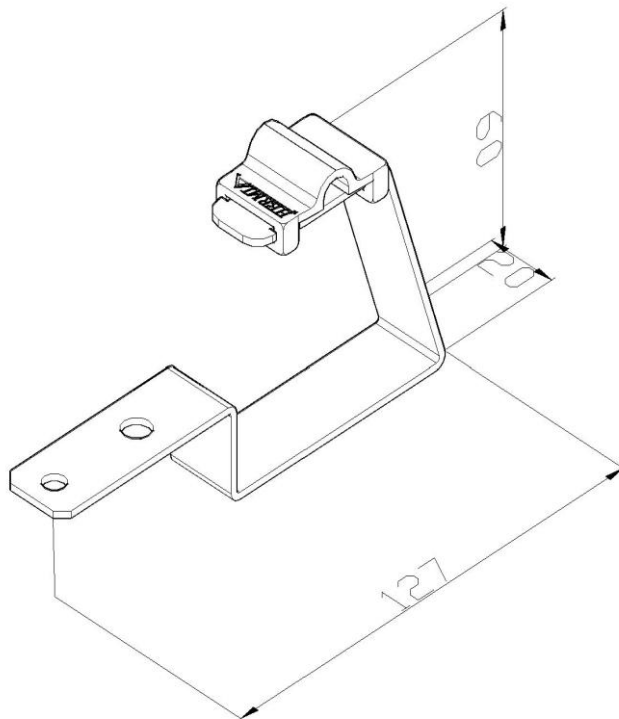

<b>Standard:</b>	EN 62561-4:2017: Lightning protection system components (LPSC) - Part 4: Requirements for conductor fasteners
<b>Dimensions:</b>	Length: 127 mm
	Width: 20 mm
	Height: 60 mm
	Conductor diameter: $\phi 8$ mm
	Weight: 0,07 kg
<b>Material:</b>	Stainless steel/resistant synthetic material - nylon