

Product: KON04 D SIMPLE

Product code: 50537

Contact clamp for lightning conductor

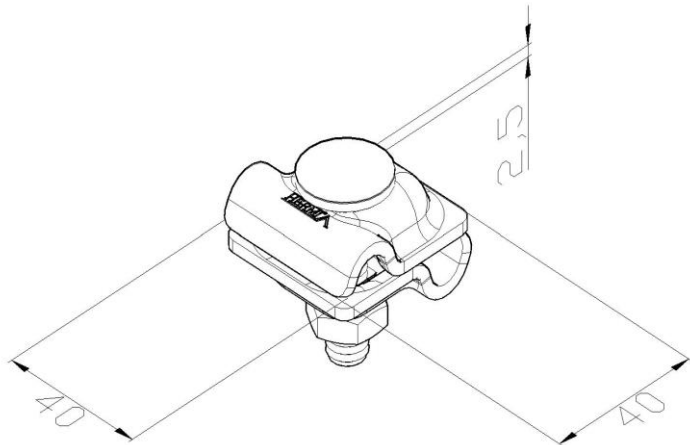

Standard:	EN 62561-1:2017: Lightning Protection System Components (LPSC) - Part 1: Requirements for connection components
Dimensions:	Length: 40 mm
	Width: 40 mm
	Height:
	Weight: 0,11 kg
	Conductor dimensions 1: $\phi 8-10$ mm
	Conductor dimensions 2: $\phi 8-10$ mm
Material:	hot-dip galvanized sheet metal
Withstand lightning current class:	H