

Product: SON04 A

Product code: 426

Roof conductor fastener

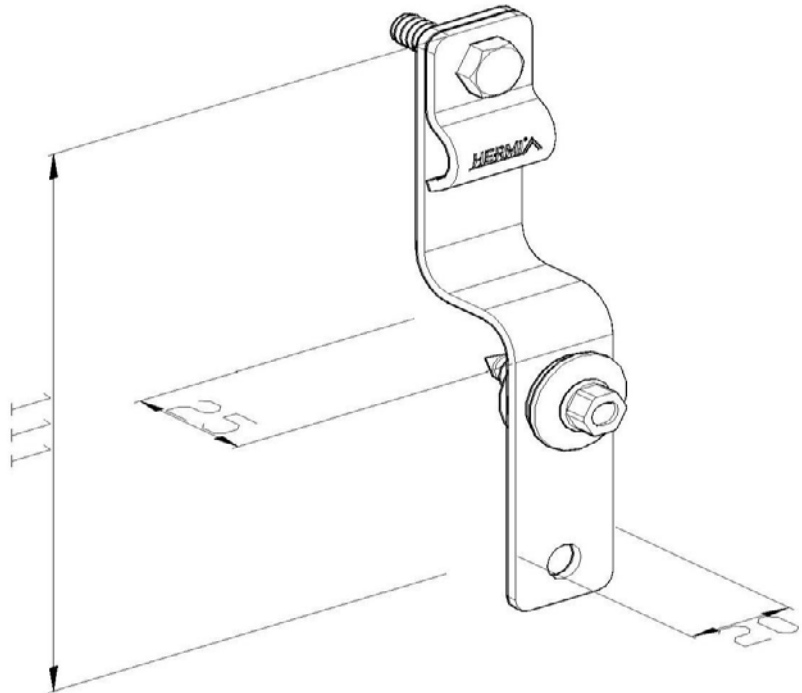

Standard:	EN 62561-4:2017: Lightning protection system components (LPSC) - Part 4: Requirements for conductor fastener
Dimensions:	Length: 20 mm
	Width: 25 mm
	Height: 111 mm
	Conductor diameter: ϕ 8-10 mm
	Weight: 0,05 kg
Material:	Stainless steel