

Product: KON71

Product code: 400710

Contact clamp for lightning conductor

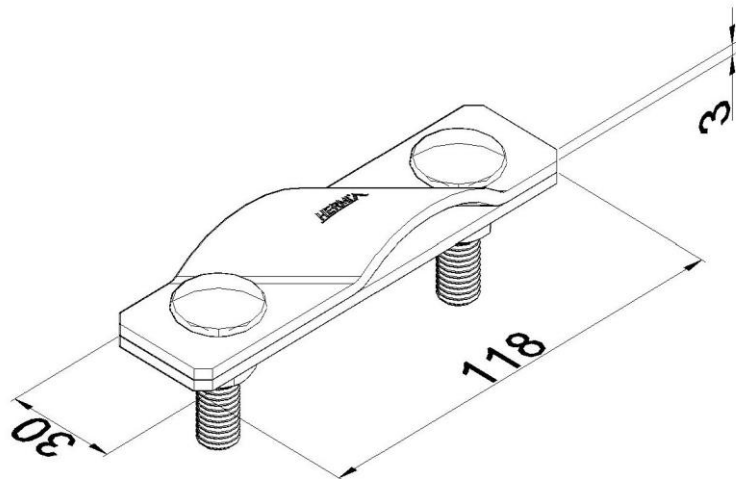

Standard:	EN 62561-1:2017: Lightning Protection System Components (LPSC) - Part 1: Requirements for connection components
Dimensions:	Length: 118 mm
	Width: 30 mm
	Height:
	Weight: 0,23 kg
	Conductor dimensions 1: $\phi 8-10$ mm
	Conductor dimensions 2: P 25-50 mm
Material:	stainless steel
Withstand lightning current class:	H