

**Product:** KON07

**Product code:** 400225

Contact clamp for lightning conductor

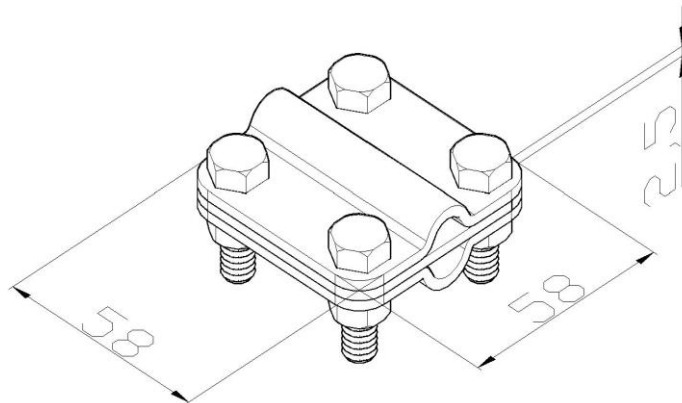

<b>Standard:</b>	EN 62561-1:2017: Lightning Protection System Components (LPSC) - Part 1: Requirements for connection components
<b>Dimensions:</b>	Length: 58 mm
	Width: 58 mm
	Height:
	Weight:
	Conductor dimensions 1: 185 mm <sup>2</sup>
	Conductor dimensions 2: 185 mm <sup>2</sup>
<b>Material:</b>	stainless steel
<b>Withstand lightning current class:</b>	H