

Product: KON07

Product code: 400215

Contact clamp for lightning conductor

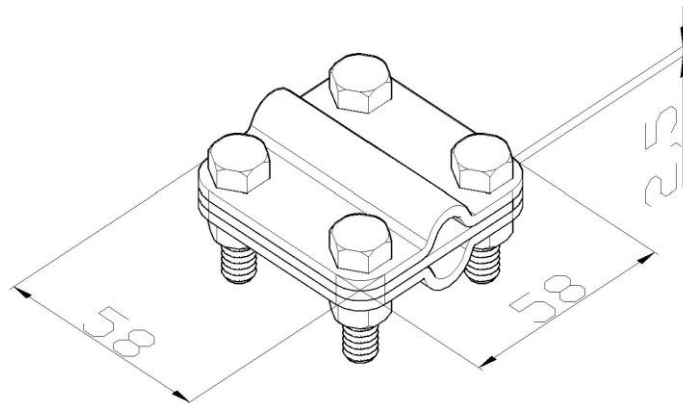

Standard:	EN 62561-1:2017: Lightning Protection System Components (LPSC) - Part 1: Requirements for connection components
Dimensions:	Length: 58 mm
	Width: 58 mm
	Height:
	Weight:
	Conductor dimensions 1: 150 mm ²
	Conductor dimensions 2: 50 mm ²
Material:	stainless steel
Withstand lightning current class:	H