

Product: VZ HOLDER 08

Product code: 309

Holder for vertical protection

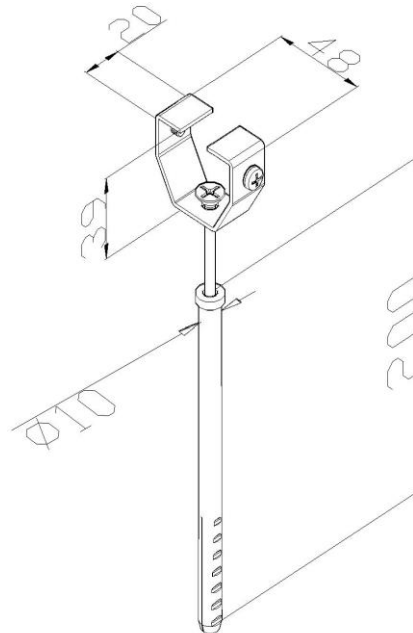

Standard:	EN 62561-4:2017: Lightning protection system components (LPSC) - Part 4: Requirements for conductor fasteners
Dimensions:	Length: 48 mm
	Width: 20 mm
	Height: 39 mm
	Screw length: 200 mm
	Wall plug diameter: $\phi 10$ mm
Weight:	0,07 kg
Material:	Acid-resistant stainless steel