

Product: ZON03 N-N brick red
22344

Product code:

Wall conductor fastener

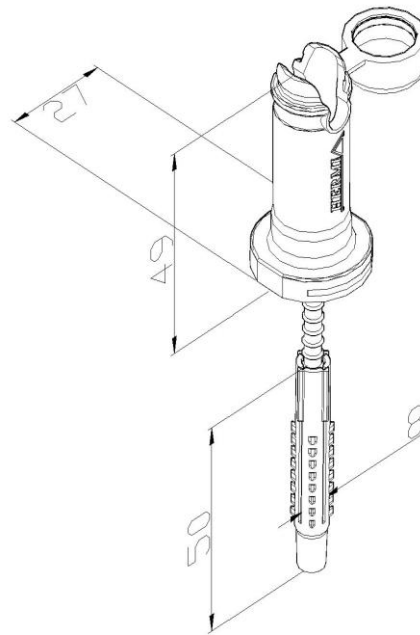

Standard:	EN 62561-4:2017: Lightning protection system components (LPSC) - Part 4: Requirements for conductor fasteners
Dimensions:	Length: 27 mm
	Width: 27 mm
	Height: 49 mm
	Conductor diameter: $\phi 8$ mm
	Screw length: 50 mm
	Wall plug diameter: $\phi 8$ mm
	Weight: 0,02 kg
Material:	Nylon