

Product: ZON03

Product code: 20332

Wall conductor fastener

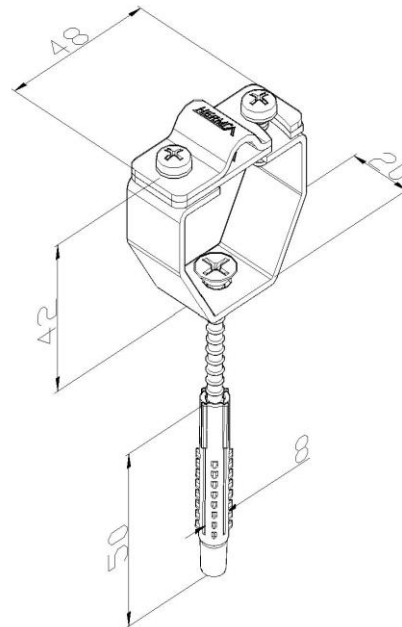

<b>Standard:</b>	EN 62561-4:2017: Lightning protection system components (LPSC) - Part 4: Requirements for conductor fasteners
<b>Dimensions:</b>	Length: 48 mm
	Width: 20 mm
	Height: 42 mm
	Conductor diameter: 240 mm <sup>2</sup>
	Screw length: 50 mm
	Wall plug diameter: $\phi$ 8 mm
<b>Material:</b>	Stainless steel