

Product: ZON03

Product code: 20331

Wall conductor fastener

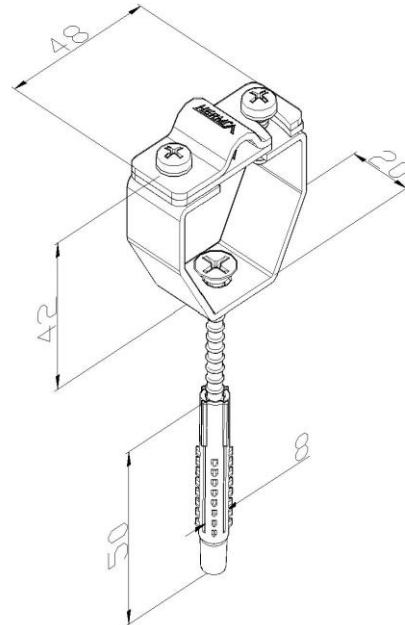

Standard:	EN 62561-4:2017: Lightning protection system components (LPSC) - Part 4: Requirements for conductor fasteners
Dimensions:	Length: 48 mm
	Width: 20 mm
	Height: 42 mm
	Conductor diameter: 185 mm ²
	Screw length: 50 mm
	Wall plug diameter: ϕ 8 mm
Material:	Stainless steel