

Product: ZON03

Product code: 20328

Wall conductor fastener

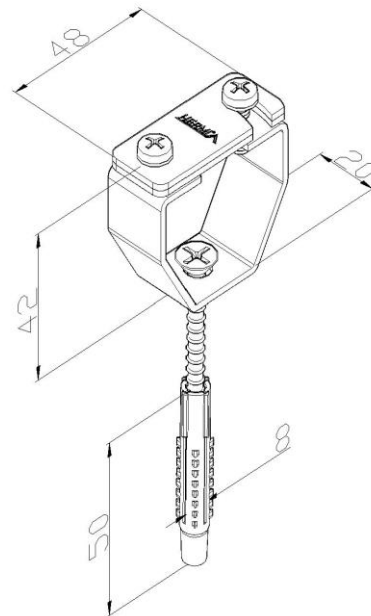

Standard:	EN 62561-4:2017: Lightning protection system components (LPSC) - Part 4: Requirements for conductor fasteners
Dimensions:	Length: 48 mm
	Width: 20 mm
	Height: 42 mm
	Conductor diameter: P up to 25x4
	Screw length: 50 mm
	Wall plug diameter: $\phi 8$ mm
Material:	Weight: Acid-resistant stainless steel