

Product: ZON01

Product code: 20129

Wall conductor fastener

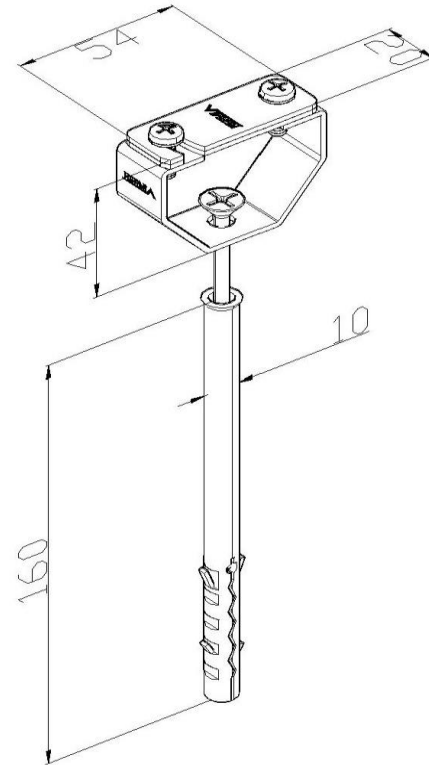

Standard:	EN 62561-4:2017: Lightning protection system components (LPSC) - Part 4: Requirements for conductor fasteners
Dimensions:	Length: 54 mm
	Width: 20 mm
	Height: 42 mm
	Conductor diameter: P up to 30x3,5
	Screw length: 160 mm
	Wall plug diameter: $\phi 10$ mm
Material:	Weight: Acid-resistant stainless steel