

Product: SON54 T

Product code: 15421

Roof conductor fastener

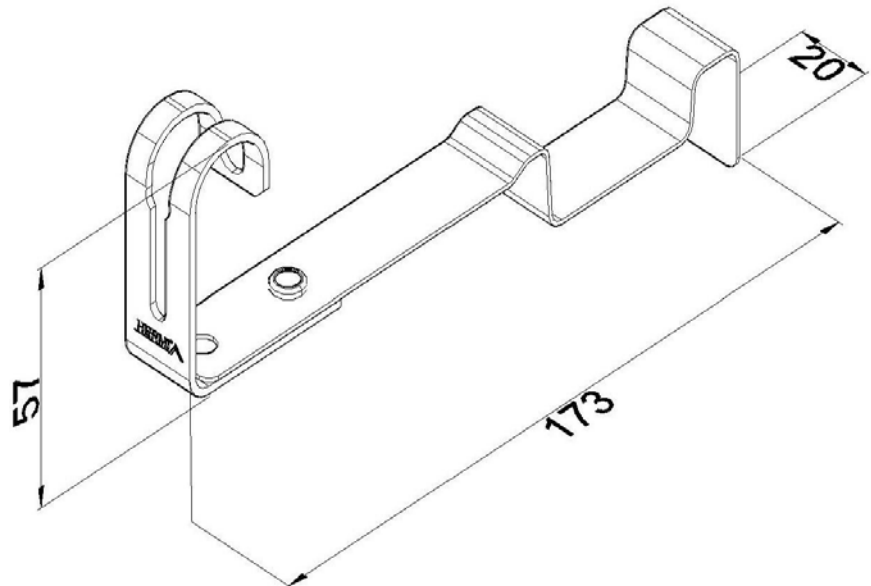

<b>Standard:</b>	EN 62561-4:2017: Lightning protection system components (LPSC) - Part 4: Requirements for conductor fastener
<b>Dimensions:</b>	Length: 173 mm
	Width: 20 mm
	Height: 57 mm
	Conductor diameter: $\phi 8$ mm
	Weight: 0,06 kg
<b>Material:</b>	Stainless steel