

Product: SON53 T

Product code: 15321

Roof conductor fastener

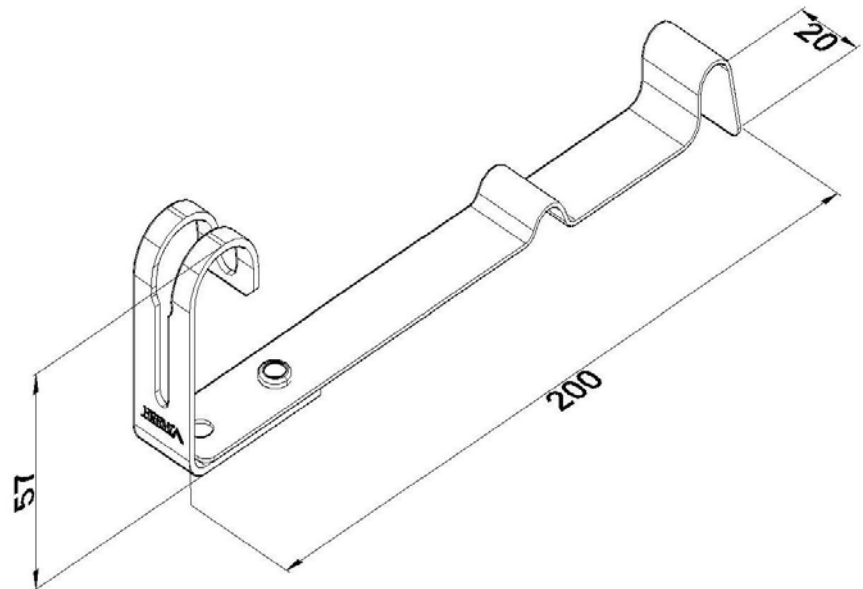

Standard:	EN 62561-4:2017: Lightning protection system components (LPSC) - Part 4: Requirements for conductor fastener
Dimensions:	Length: 200 mm
	Width: 20 mm
	Height: 57 mm
	Conductor diameter: $\phi 8$ mm
	Weight: 0,06 kg
Material:	Stainless steel