

**Product:** SON47

**Product code:** 14727

Roof conductor fastener

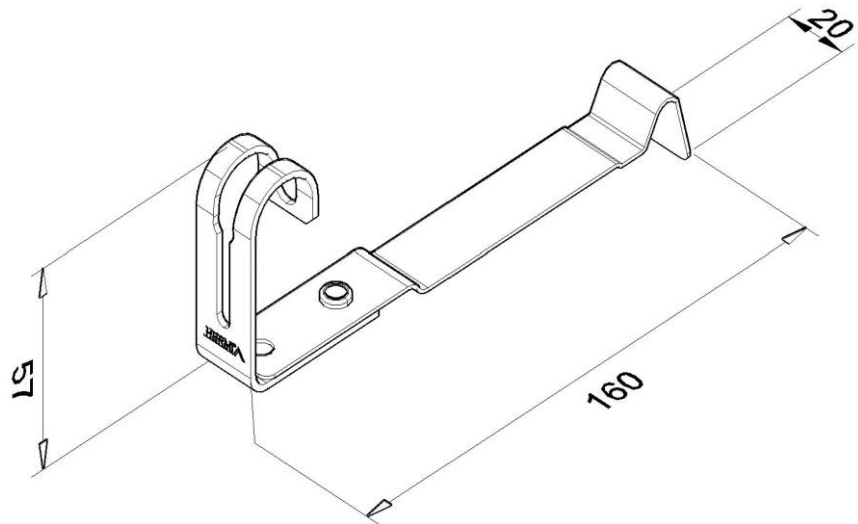

<b>Standard:</b>	EN 62561-4:2017: Lightning protection system components (LPSC) - Part 4: Requirements for conductor fastener
<b>Dimensions:</b>	Length: 160 mm
	Width: 20 mm
	Height: 57 mm
	Conductor diameter: $\phi 8$ mm
<b>Material:</b>	Weight: Acid-resistant stainless steel