

Product: SON45

Product code: 14527

Roof conductor fastener

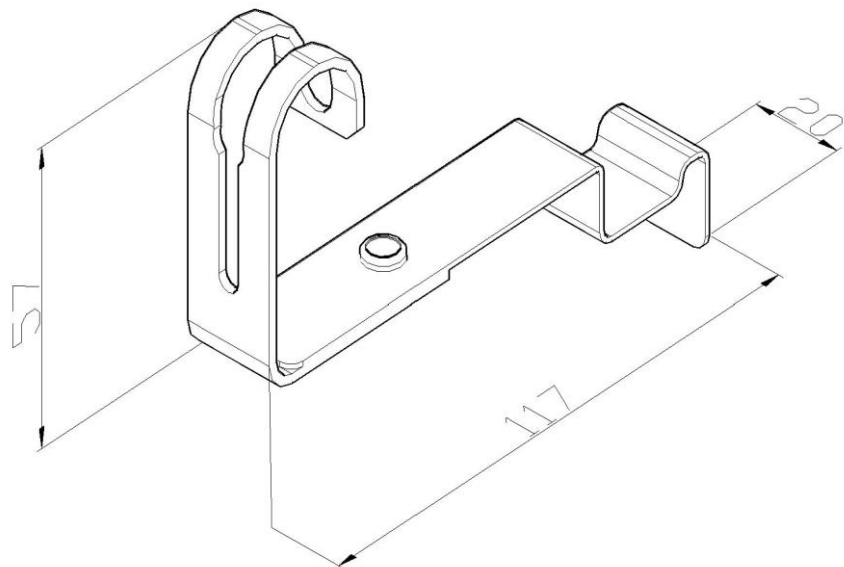

Standard:	EN 62561-4:2017: Lightning protection system components (LPSC) - Part 4: Requirements for conductor fastener
Dimensions:	Length: 117 mm
	Width: 20 mm
	Height: 57 mm
	Conductor diameter: $\phi 8$ mm
	Weight: 0,05 kg
Material:	Acid-resistant stainless steel