

Product: SON43

Product code: 14321

Roof conductor fastener

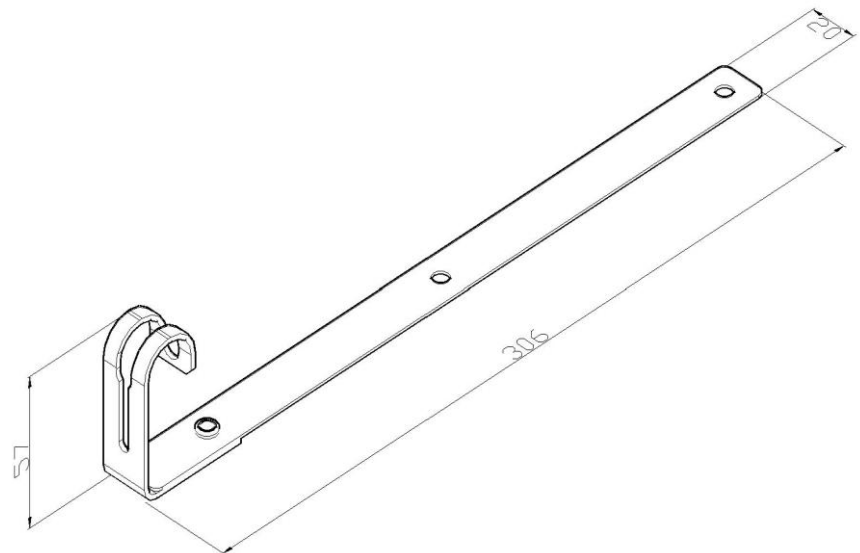

| | |
|--------------------|--|
| Standard: | EN 62561-4:2017: Lightning protection system components (LPSC) - Part 4: Requirements for conductor fastener |
| Dimensions: | Length: 306 mm |
| | Width: 20 mm |
| | Height: 57 mm |
| | Conductor diameter: $\phi 8$ mm |
| | Weight: 0,08 kg |
| Material: | Stainless steel |