

Product: SON14

Product code: 1427

Roof conductor fastener

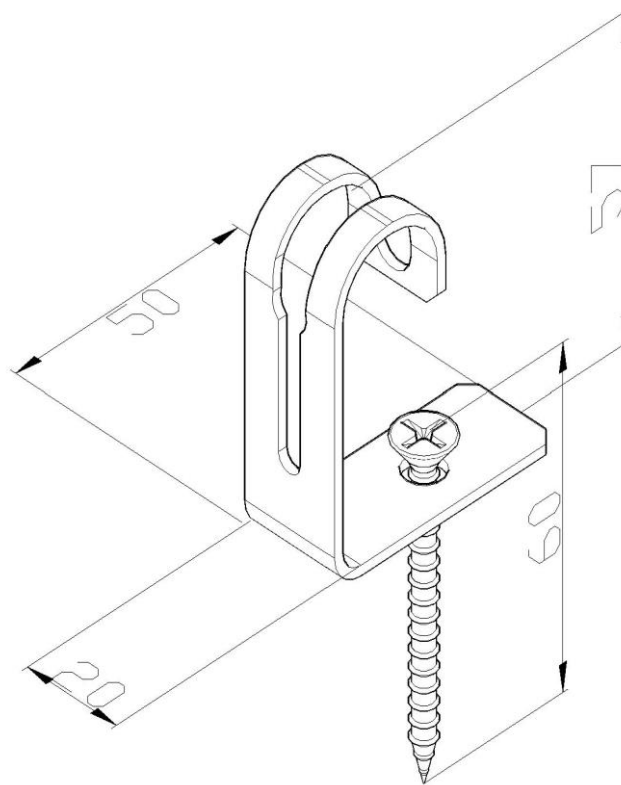

Standard:	EN 62561-4:2017: Lightning protection system components (LPSC) - Part 4: Requirements for conductor fastener
Dimensions:	Length: 50 mm
	Width: 20 mm
	Height: 57 mm
	Conductor diameter: $\phi 8$ mm
Material:	Weight: Acid-resistant stainless steel