

Product: SON27

Product code: 12723

Roof conductor fastener

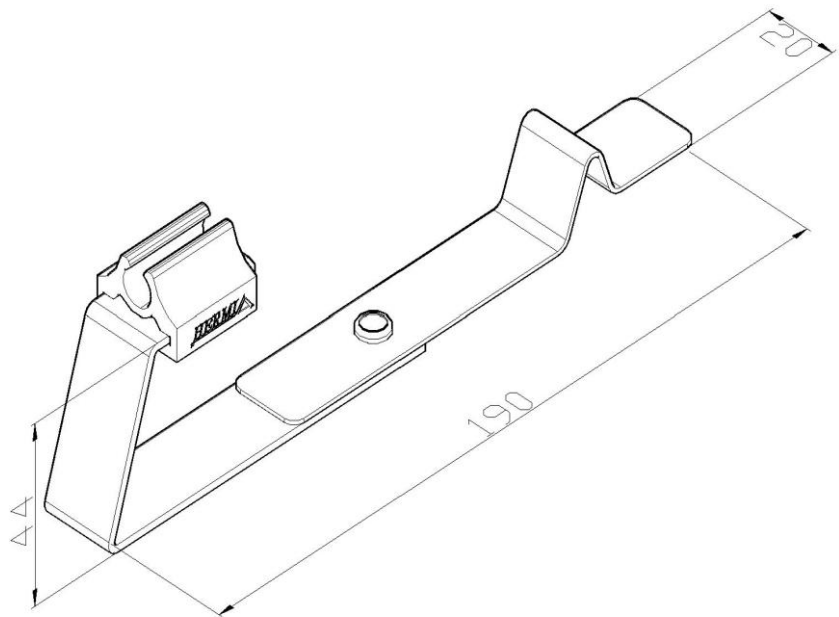

Standard:	EN 62561-4:2017: Lightning protection system components (LPSC) - Part 4: Requirements for conductor fastener
Dimensions:	Length: 190 mm
	Width: 20 mm
	Height: 44 mm
	Conductor diameter: $\phi 10$ mm
	Weight: 0,08 kg
Material:	Stainless steel - nylon