

**Product:** SON26

**Product code:** 12621

Roof conductor fastener

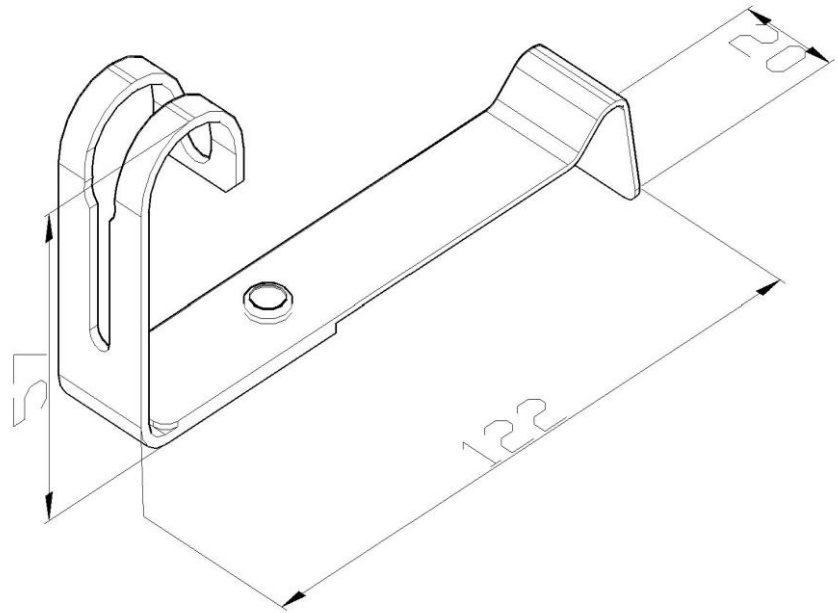

<b>Standard:</b>	EN 62561-4:2017: Lightning protection system components (LPSC) - Part 4: Requirements for conductor fastener
<b>Dimensions:</b>	Length: 122 mm
	Width: 20 mm
	Height: 57 mm
	Conductor diameter: $\phi 8$ mm
	Weight: 0,05 kg
<b>Material:</b>	Stainless steel