

Product: SON24

Product code: 12422

Roof conductor fastener

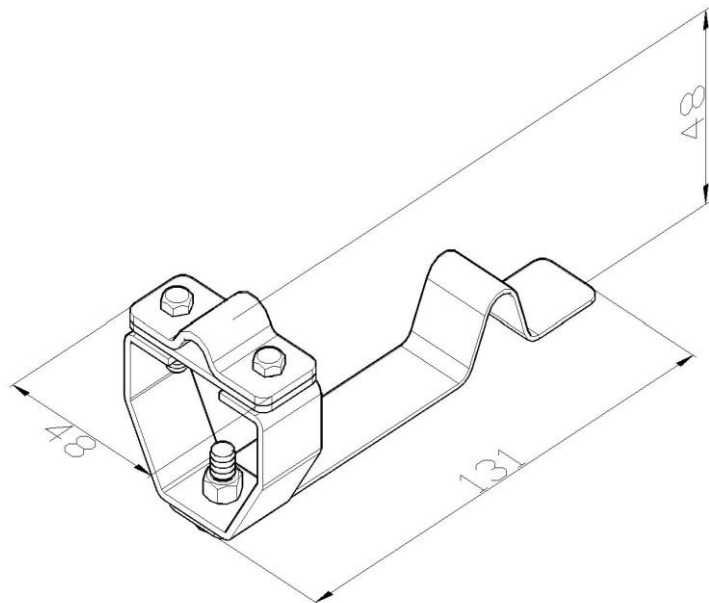

Standard:	EN 62561-4:2017: Lightning protection system components (LPSC) - Part 4: Requirements for conductor fastener
Dimensions:	Length: 131 mm
	Width: 48 mm
	Height: 48 mm
	Conductor diameter: ϕ 8-10 mm
	Weight: 0,05 kg
Material:	Stainless steel