

**Product:** SON16

**Product code:** 11631

Roof conductor fastener

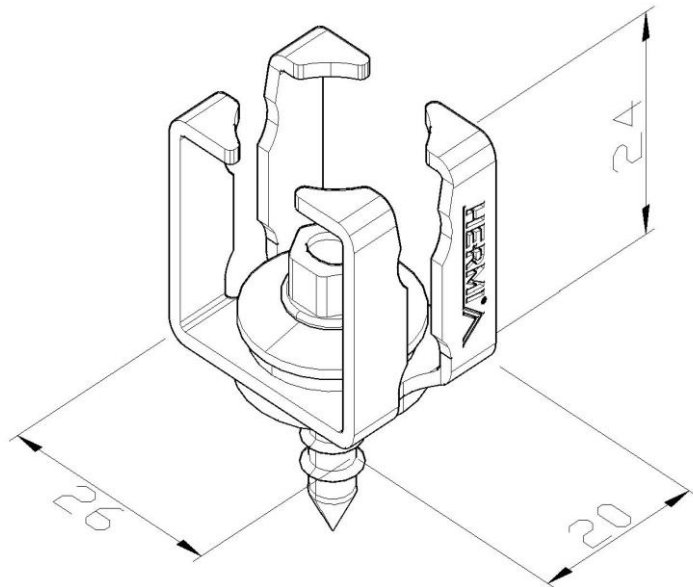

<b>Standard:</b>	EN 62561-4:2017: Lightning protection system components (LPSC) - Part 4: Requirements for conductor fastener
<b>Dimensions:</b>	Length: 20 mm
	Width: 26 mm
	Height: 24 mm
	Conductor diameter: $\phi 8$ mm
<b>Material:</b>	Stainless steel