

Product: SON15 brown

Product code: 115230

Roof conductor fastener

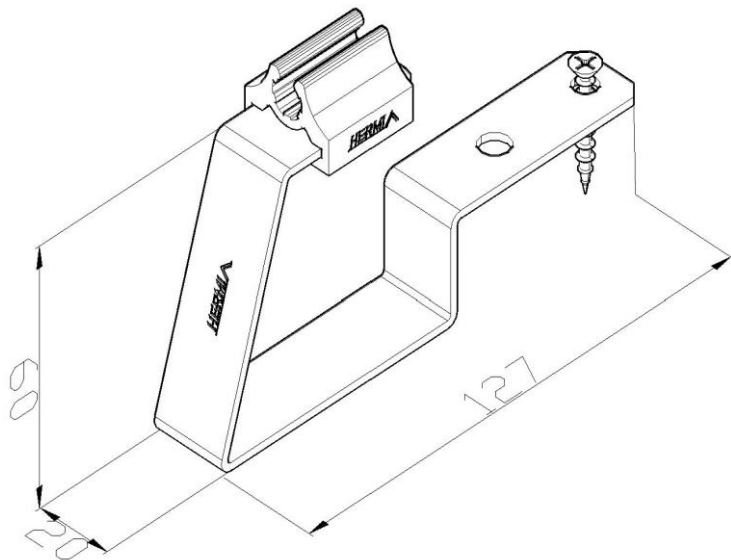

Standard:	EN 62561-4:2017: Lightning protection system components (LPSC) - Part 4: Requirements for conductor fastener
Dimensions:	Length: 127 mm
	Width: 20 mm
	Height: 60 mm
	Conductor diameter: $\phi 10$ mm
	Weight: 0,08 kg
Material:	Stainless steel/resistant synthetic material - nylon