

Product: SON13 A grey

Product code: 113301

Roof conductor fastener

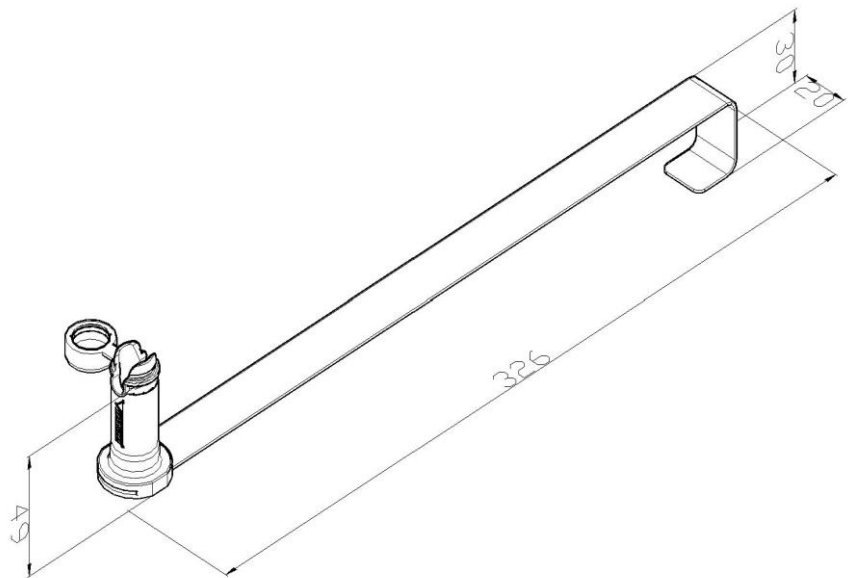

Standard:	EN 62561-4:2017: Lightning protection system components (LPSC) - Part 4: Requirements for conductor fastener
Dimensions:	Length: 326 mm
	Width: 20 mm
	Height: 49 mm
	Conductor diameter: $\phi 8$ mm
	Weight: 0,07 kg
Material:	Stainless steel - nylon