

Product: KON30

Product code: 110049

Bonding conector

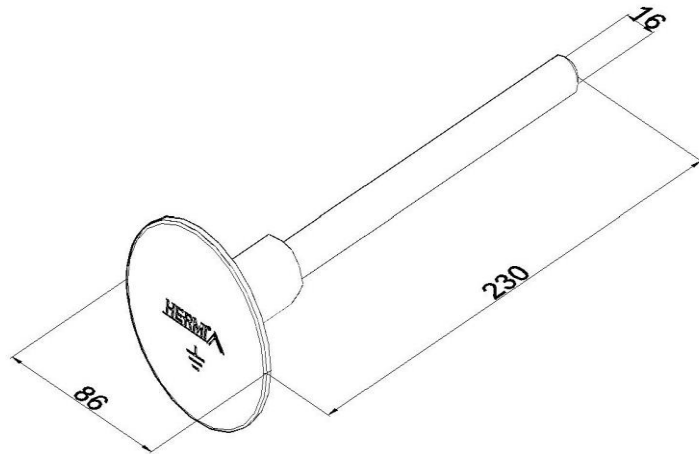

Standard:	EN IEC 62561-2:2018 : Lightning Protection System Components (LPSC) - Part 2: Requirements for conductors and earth electrodes
Dimensions:	Length: 230 mm
	Width: 86 mm
	Height:
	Diameter: 16 mm
	Conductor dimensions:
Material:	Acid-resistant stainless steel