

Product: ISVH 3,0

Product code: 100103

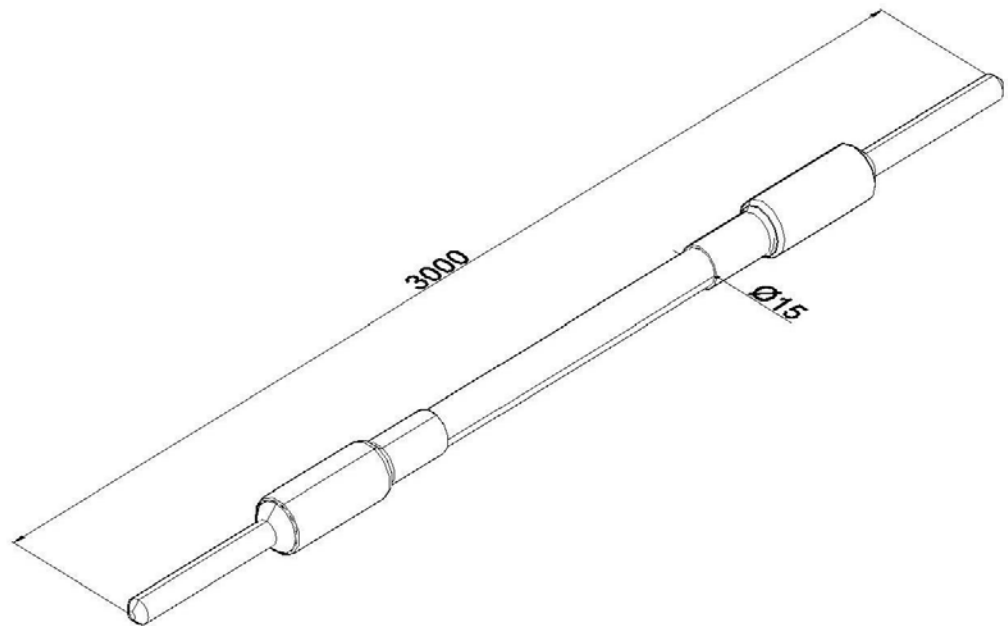

Standard:	EN IEC 62561-2:2018: Lightning Protection System Components (LPSC) - Part 2: Requirements for conductors and earth electrodes
Dimensions:	Length: 3 m
	Width:
	Height:
	Diameter: ϕ 15 mm
	Weight:
Material:	