

Product: ISVH 2,0

Product code: 100102

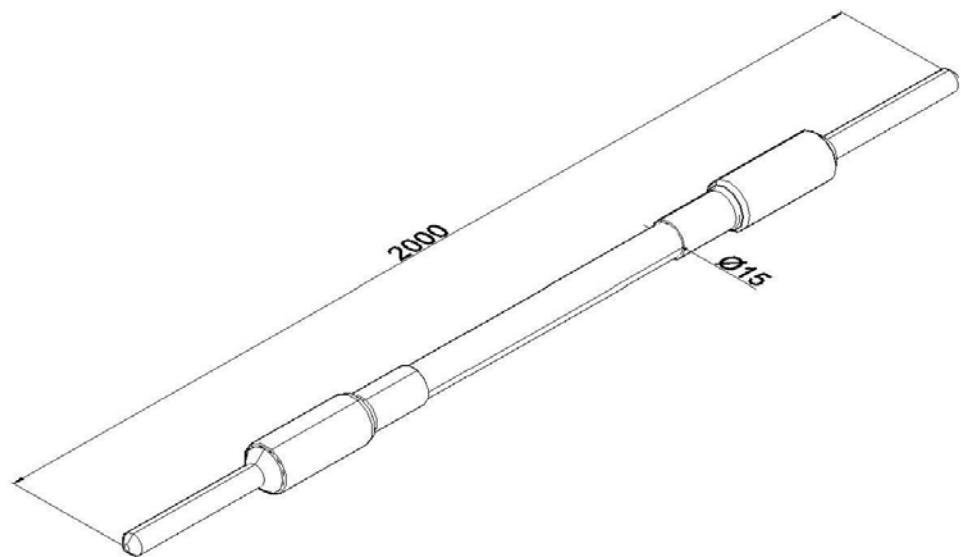

<b>Standard:</b>	EN IEC 62561-2:2018: Lightning Protection System Components (LPSC) - Part 2: Requirements for conductors and earth electrodes
<b>Dimensions:</b>	Length: 2 m
	Width:
	Height:
	Diameter: $\phi 15$ mm
	Weight:
<b>Material:</b>	