

Product: ISVH 1,0

Product code: 100101

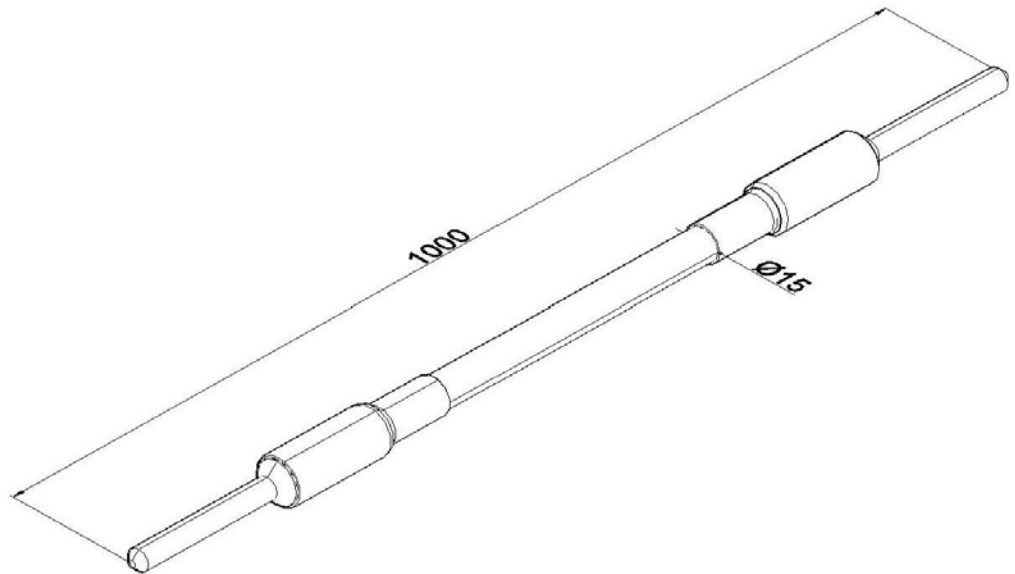

<b>Standard:</b>	EN IEC 62561-2:2018: Lightning Protection System Components (LPSC) - Part 2: Requirements for conductors and earth electrodes
<b>Dimensions:</b>	Length: 1 m
	Width:
	Height:
	Diameter: $\phi$ 15 mm
	Weight:
<b>Material:</b>	