

Product: PKP-GS 60

Product code: 88725196

Flexible coupling element

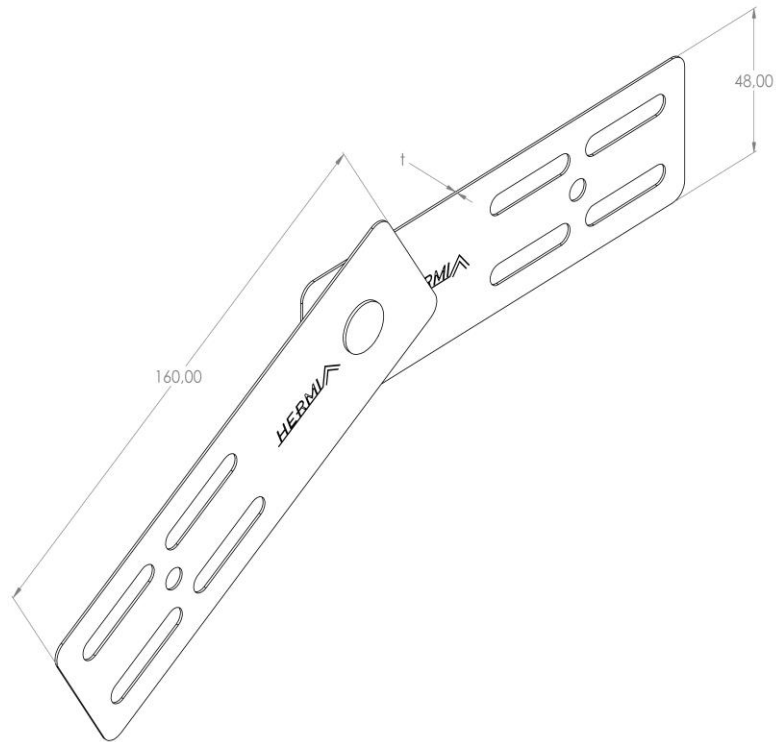

Standard:	EN 61537:2007 Cable management - Cable tray systems and cable ladder systems
Dimensions:	Length: 160 mm
	Width: 1,50 mm
	Height: 48 mm
	Metal thickness: 1,50 mm
Weight:	0,17 kg
Material:	Stainless steel
Contribution to fire:	Non-flame propagating system
Electrical characteristics:	Electrically conductive system
Electrical continuity:	Yes
Corrosion resistance:	Class 9A
Temperature:	Min: -20°C; Max: +105°C