

Product: KP 40/100

Product code: 88722031

Cable trays of 40 mm in height

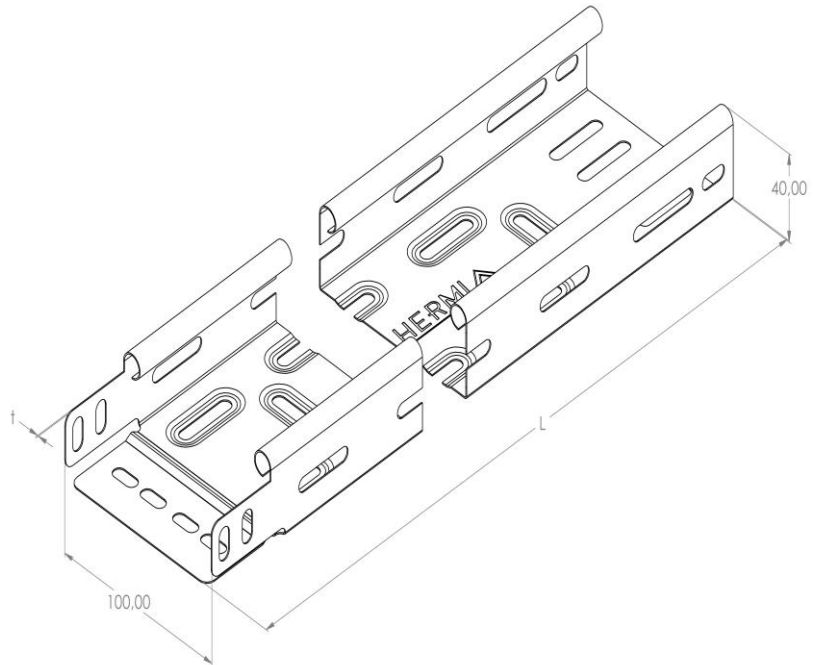

Standard:	EN 61537:2007 Cable management - Cable tray systems and cable ladder systems
Dimensions:	Length: 3000 mm
	Width: 100 mm
	Height: 40 mm
	Metal thickness: 0,60 mm
Weight:	2,7 kg
Material:	Stainless steel
Contribution to fire:	Non-flame propagating system
Electrical characteristics:	Electrically conductive system
Electrical continuity:	Yes
Corrosion resistance:	Class 9A
Perforation:	Class B
Temperature:	Min: -20°C; Max: +105°C

Permissible load KP 40/100 d=0,6mm (kN/m)

