

Product: KPU 60/600

Product code: 88722006

Non-perforated cable trays of 60 mm in height

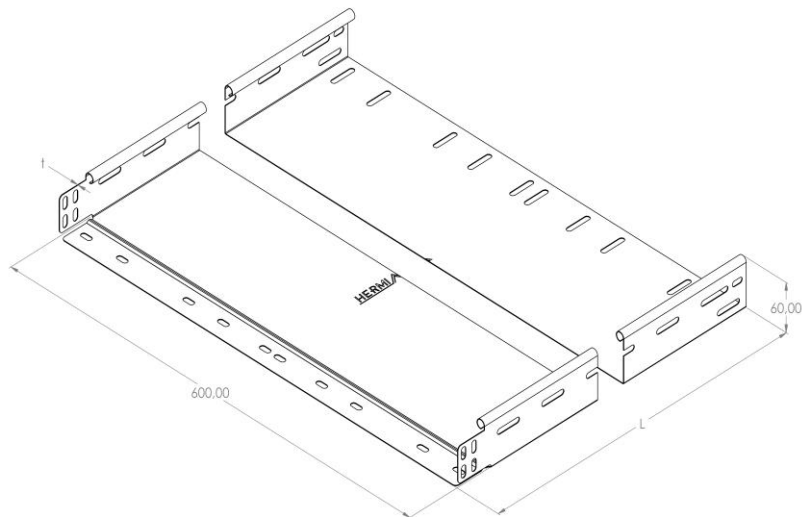

Standard:	EN 61537:2007 Cable management - Cable tray systems and cable ladder systems
Dimensions:	Length: 2000 mm
	Width: 600 mm
	Height: 60 mm
	Metal thickness: 0,80 mm
Weight:	9,6 kg
Material:	Stainless steel
Contribution to fire:	Non-flame propagating system
Electrical characteristics:	Electrically conductive system
Electrical continuity:	Yes
Corrosion resistance:	Class 9A
Perforation:	Class B
Temperature:	Min: -20°C; Max: +105°C

Permissible load KP 60/600 d=0,8mm (kN/m)

