

Product: NPK-WK 310

Product code: 88719003

Welded wall bracket

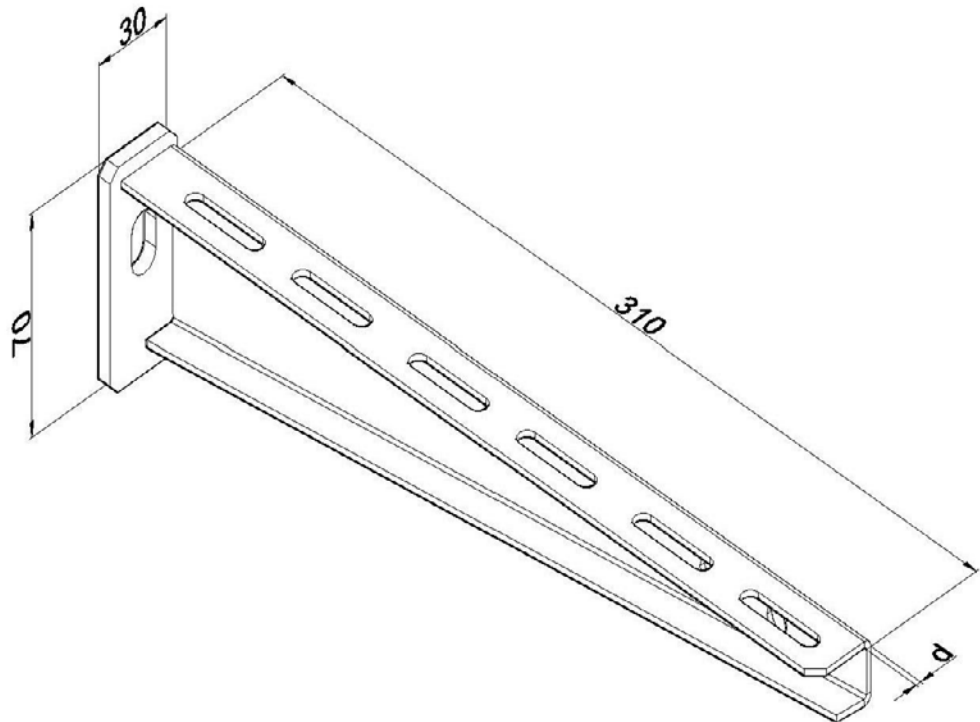

Standard:	EN 61537:2007 Cable management - Cable tray systems and cable ladder systems
Dimensions:	Length: 310 mm
	Width: 30 mm
	Height: 70 mm
	Metal thickness: 1,5 mm
Maximum load:	2,6 kN
Weight:	0,41 kg
Material:	Hot-dip galvanised steel
Contribution to fire:	Non-flame propagating system
Electrical characteristics:	Electrically conductive system
Electrical continuity:	Yes
Corrosion resistance:	Class 6
Temperature:	Min: -20°C; Max: +105°C