

Product: PKP-GSH 60

Product code: 88718906

Horizontal flexible joint

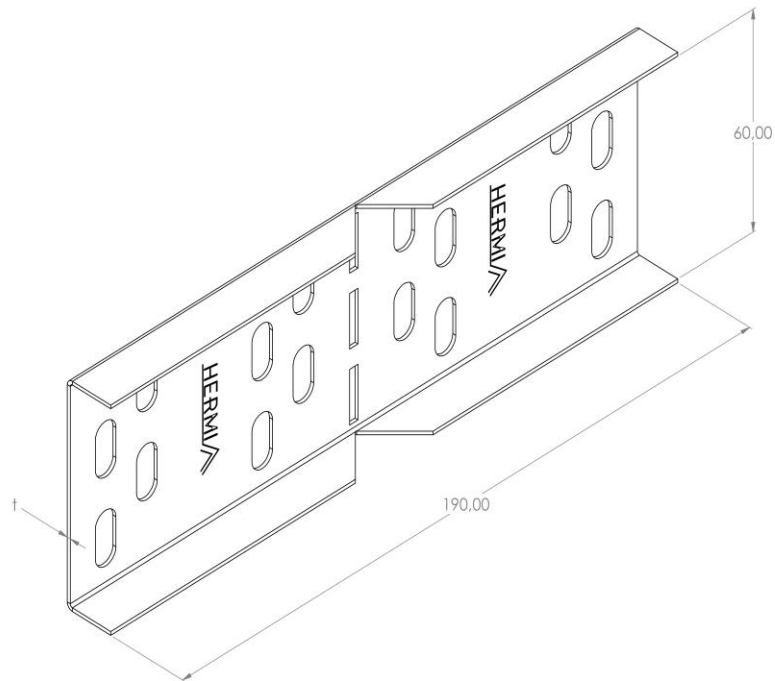

Standard:	EN 61537:2007 Cable management - Cable tray systems and cable ladder systems
Dimensions:	Length: 190 mm
	Width: 15,00 mm
	Height: 60 mm
	Metal thickness: 1,50 mm
Weight:	0,2 kg
Material:	Hot-dip galvanised steel
Contribution to fire:	Non-flame propagating system
Electrical characteristics:	Electrically conductive system
Electrical continuity:	Yes
Corrosion resistance:	Class 6
Temperature:	Min: -20°C; Max: +105°C