

Product: NKP-SNL/OMEGA 110

Product code: 88718871

Wall bracket

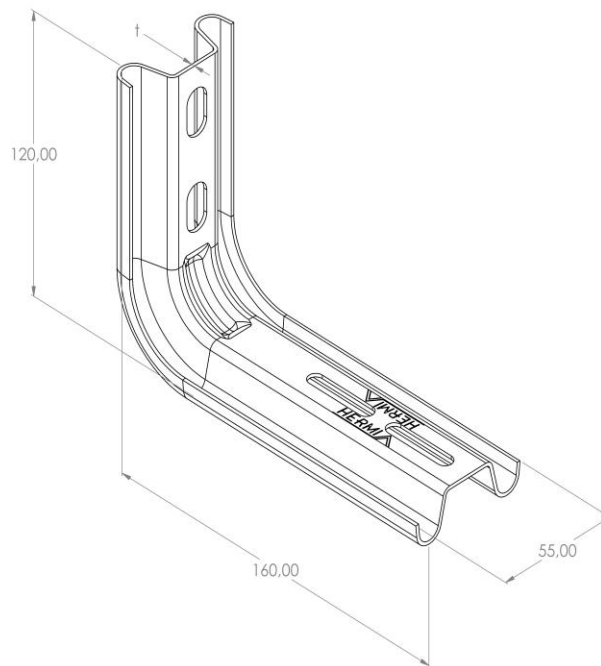

Standard:	EN 61537:2007 Cable management - Cable tray systems and cable ladder systems
Dimensions:	Length: 160 mm
	Width: 55 mm
	Height: 120 mm
	Metal thickness: 1,5 mm
Maximum load:	1,2 kN
Weight:	0,29 kg
Material:	Hot-dip galvanised steel
Contribution to fire:	Non-flame propagating system
Electrical characteristics:	Electrically conductive system
Electrical continuity:	Yes
Corrosion resistance:	Class 6
Temperature:	Min: -20°C; Max: +105°C