

Product: PKL-KOB05 28-40

Product code: 88717021

Cable clamp

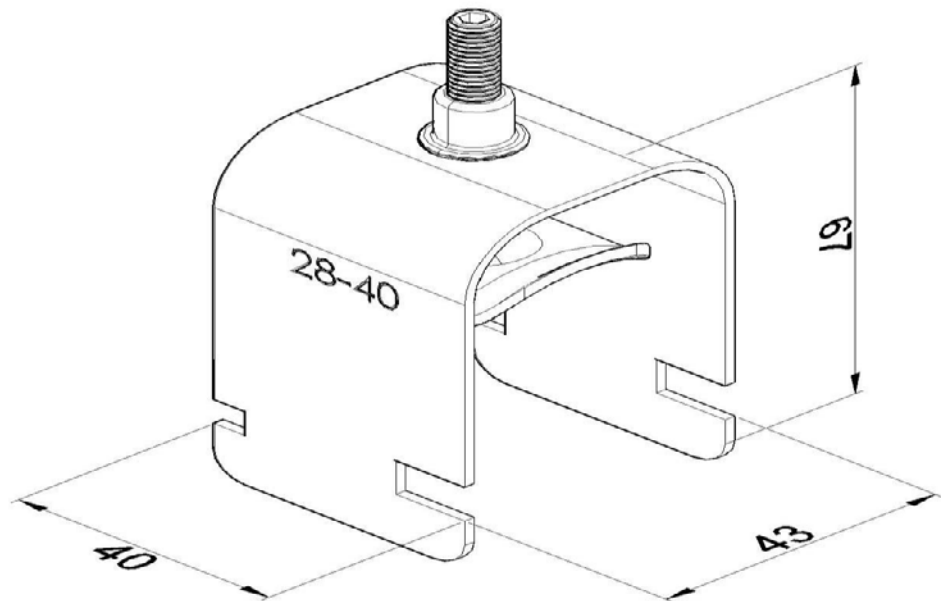

Standard:	EN 61537:2007 Cable management - Cable tray systems and cable ladder systems
Dimensions:	Length: 40 mm
	Width: Conductor width 28-40 mm
	Height: 67 mm
	Metal thickness: 2 mm
Weight:	0,1 kg
Material:	Hot-dip galvanised steel
Contribution to fire:	Non-flame propagating system
Electrical characteristics:	Electrically conductive system
Electrical continuity:	Yes
Corrosion resistance:	Class 6
Temperature:	Min: -20°C; Max: +105°C