

Product: PKL-ZNK 100/800

Product code: 88716888

External / internal elbow

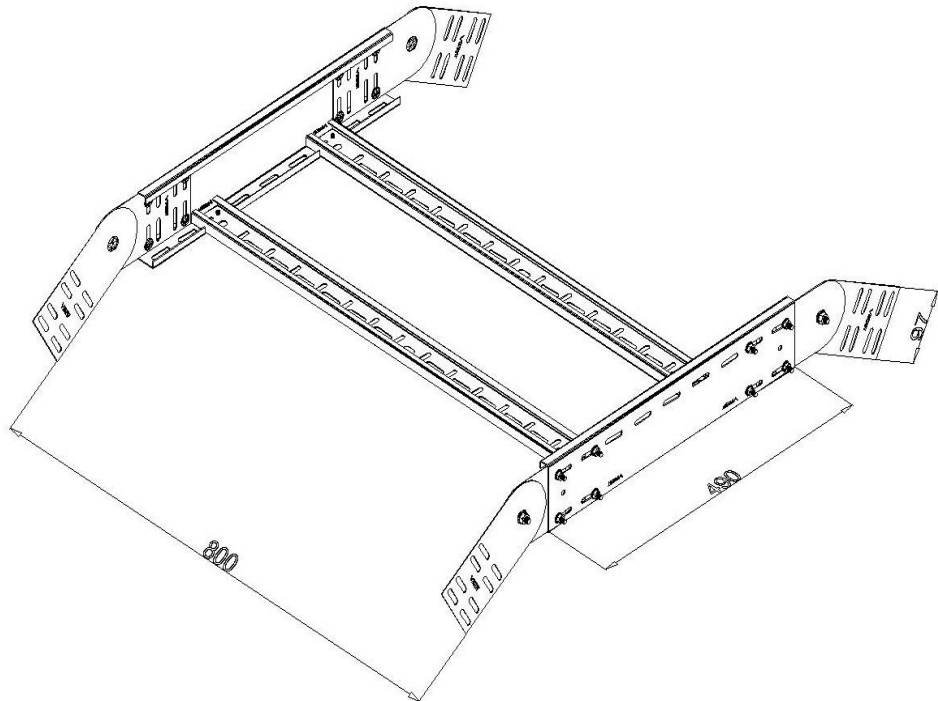

Standard:	EN 61537:2007 Cable management - Cable tray systems and cable ladder systems
Dimensions:	Length: 490 mm
	Width: 800 mm
	Height: 97 mm
	Metal thickness: 1,5 mm
Weight:	
Material:	Hot-dip galvanised steel
Contribution to fire:	Non-flame propagating system
Electrical characteristics:	Electrically conductive system
Electrical continuity:	Yes
Corrosion resistance:	Class 6
Temperature:	Min: -20°C; Max: +105°C