

Product: PKL-KOB05 10-28

Product code: 88714710

Cable clamp

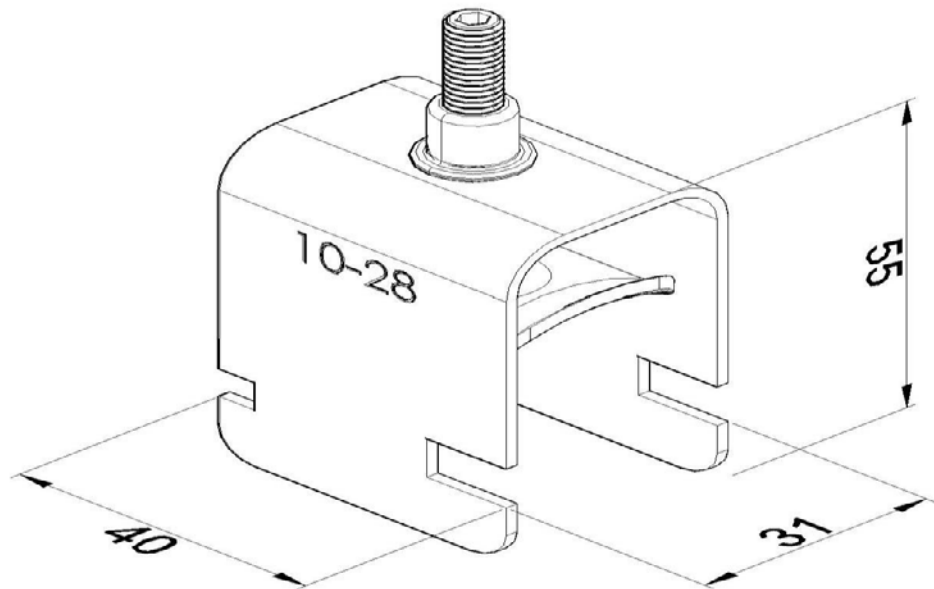

Standard:	EN 61537:2007 Cable management - Cable tray systems and cable ladder systems
Dimensions:	Length: 40 mm
	Width: Conductor width 10-28 mm
	Height: 55 mm
	Metal thickness: 2 mm
Weight:	0,07 kg
Material:	Acid resistant stainless steel
Contribution to fire:	Non-flame propagating system
Electrical characteristics:	Electrically conductive system
Electrical continuity:	Yes
Corrosion resistance:	Class 9B
Temperature:	Min: -20°C; Max: +105°C