

Product: PKL-KOB05 40-52

Product code: 88712512

Cable clamp

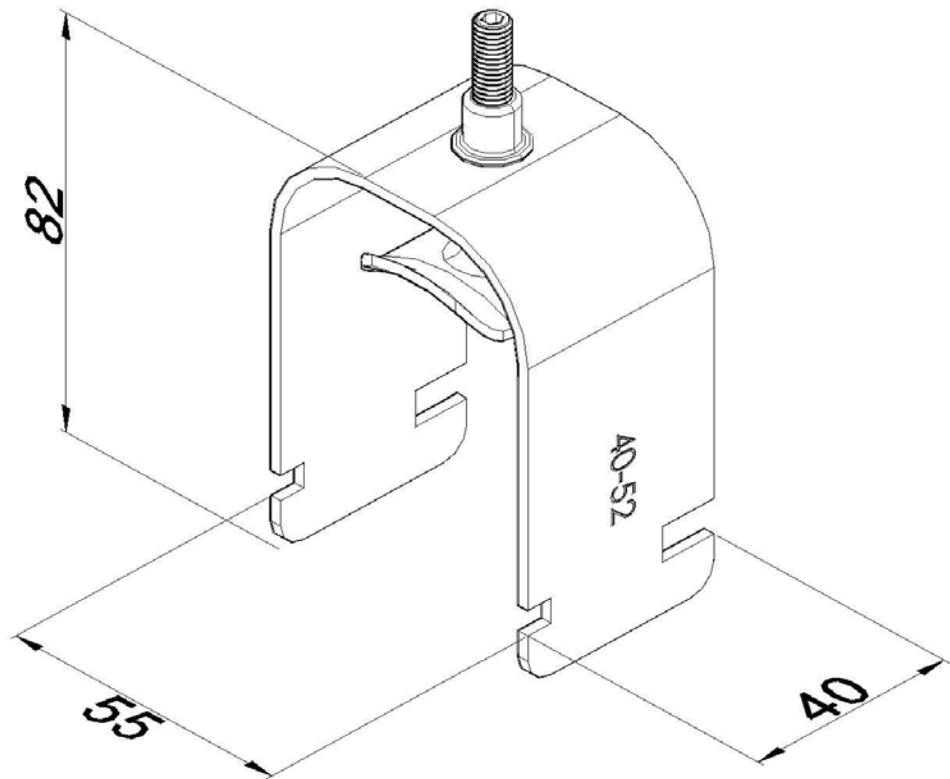

| | |
|------------------------------------|--|
| Standard: | EN 61537:2007 Cable management - Cable tray systems and cable ladder systems |
| Dimensions: | Length: 55 mm |
| | Width: Conductor width 40-52 mm |
| | Height: 82 mm |
| | Metal thickness: 2 mm |
| Weight: | 0,1 kg |
| Material: | Stainless steel |
| Contribution to fire: | Non-flame propagating system |
| Electrical characteristics: | Electrically conductive system |
| Electrical continuity: | Yes |
| Corrosion resistance: | Class 9A |
| Temperature: | Min: -20°C; Max: +105°C |