

Product: PKL-REL 100/400/300

Product code: 88712494

Reduction element - left

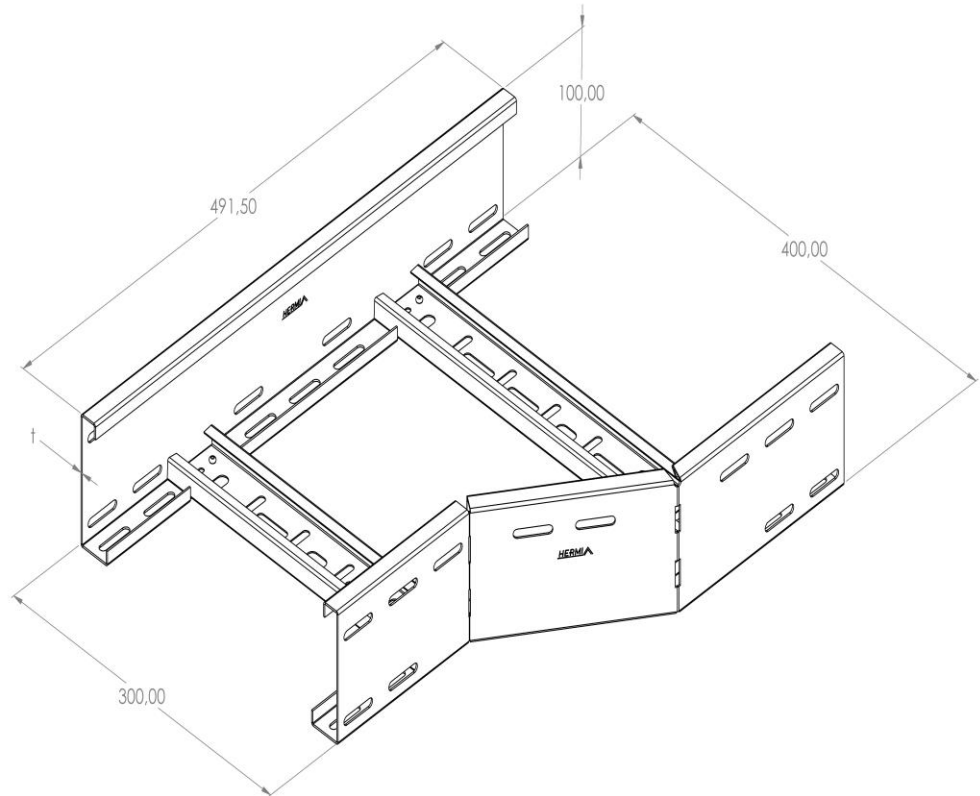

Standard:	EN 61537:2007 Cable management - Cable tray systems and cable ladder systems
Dimensions:	Length: 491,5 mm
	Width: Reduced width 400/300 mm
	Height: 100 mm
	Metal thickness: 1,5 mm
Weight:	
Material:	Stainless steel
Contribution to fire:	Non-flame propagating system
Electrical characteristics:	Electrically conductive system
Electrical continuity:	Yes
Corrosion resistance:	Class 9A
Temperature:	Min: -20°C; Max: +105°C